

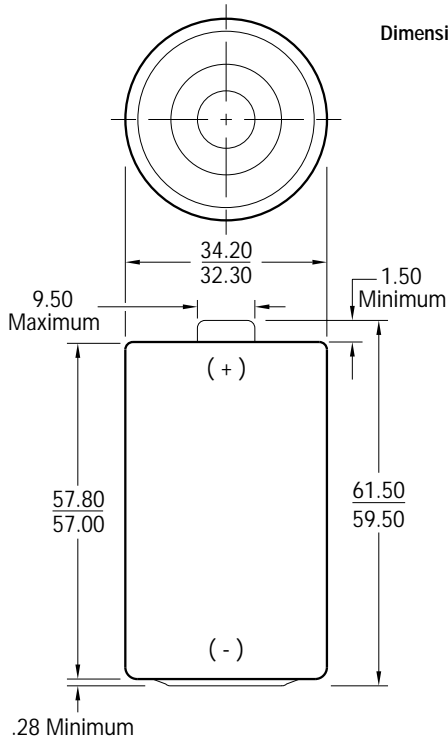

Eveready Battery Company, Inc.  
 Checkerboard Square  
 St. Louis, MO 63164  
 Telephone: 1-800-383-7323  
 Internet: www.energizer.com

## Engineering Data

### ENERGIZER NO. EN95



Dimensions (mm)

| Millimeters | Inches |
|-------------|--------|
| .28         | .011   |
| 1.50        | .059   |
| 9.50        | .374   |
| 32.30       | 1.272  |
| 34.20       | 1.346  |
| 57.00       | 2.244  |
| 57.80       | 2.276  |
| 59.50       | 2.343  |
| 61.50       | 2.421  |

**D**

Alkaline 1.5V

No Added Mercury or Cadmium

**NOT INTENDED FOR RETAIL TRADE**

**Chemical System:** Alkaline-Manganese Dioxide (Zn/MnO<sub>2</sub>)

**Designation:** ANSI-13A, IEC-LR20

**Battery Voltage:** 1.5 Volts

**Average Weight:** 141.9 grams (5.0 oz.)

**Volume:** 55.9 cubic centimeters (3.4 cubic inch)

**Average Service Capacity ( to 0.8 Volt / cell ): 18 Ah**  
 ( Rated capacity at 25 mA continuous drain )

**Cell:** One No. 3-350 (size "D")

**Jacket:** Plastic Label

**TEMPERATURE EFFECTS**  
 Typical Service to 0.8 volts

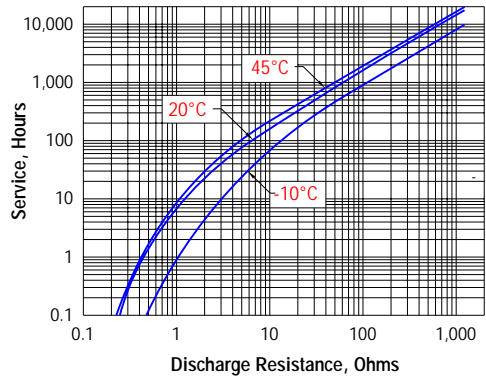

**CONSTANT RESISTANCE PERFORMANCE**  
 Typical Service

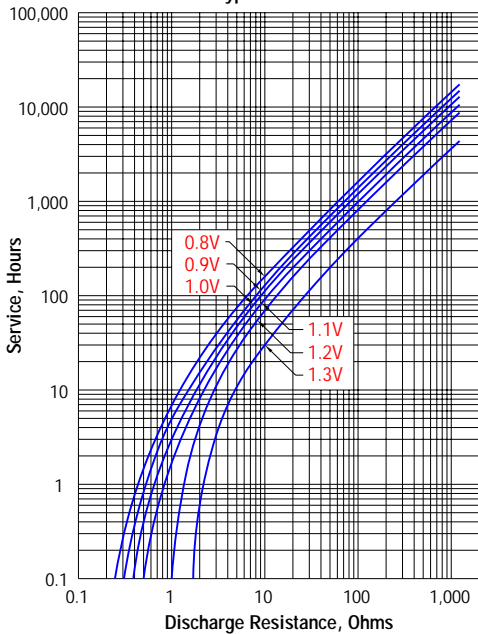

**CONSTANT CURRENT PERFORMANCE**  
 Typical Service

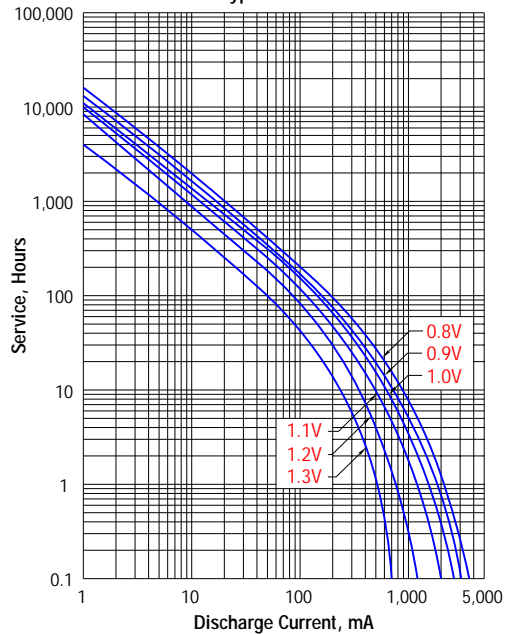

# ENERGIZER NO. EN95

Internal Resistance  
Typical Values at 20°C (70°F)

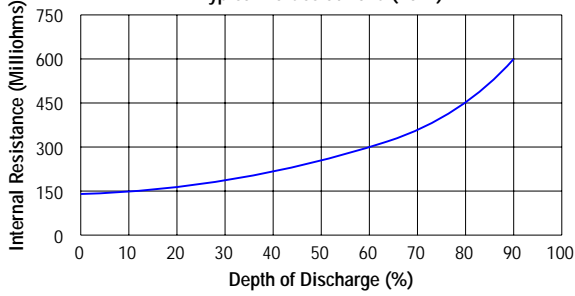

## TYPICAL APPLICATIONS

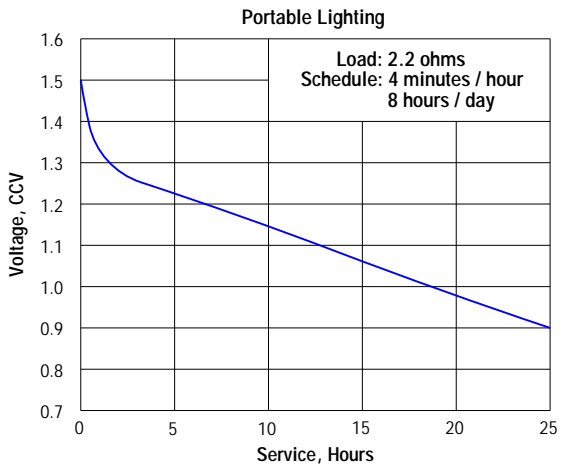
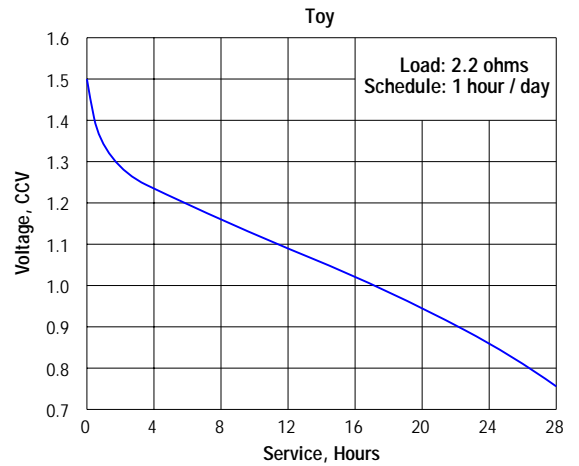
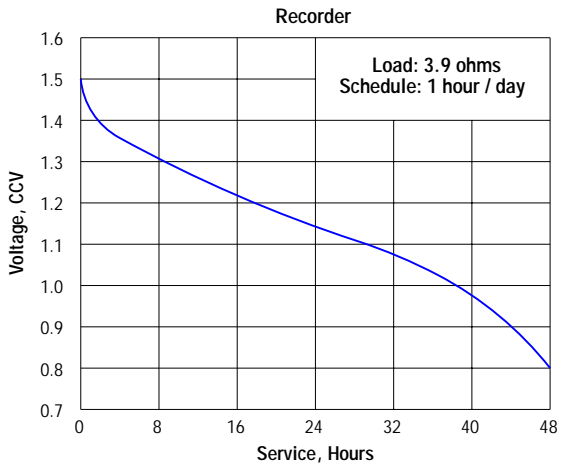
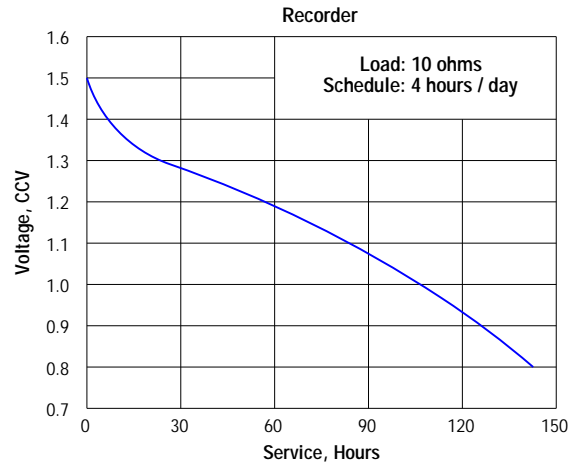
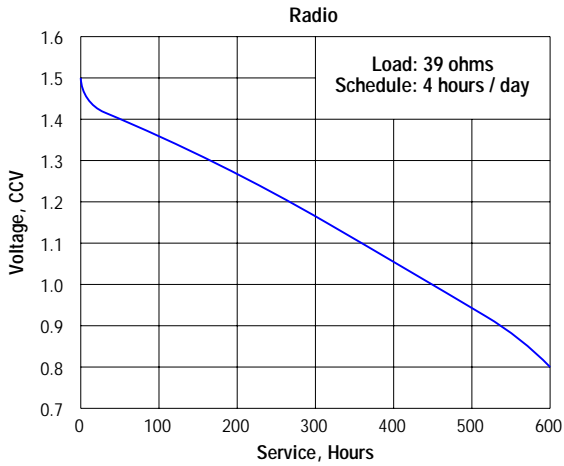

### IMPORTANT NOTICE

This data sheet contains information specific to batteries manufactured at time of its publication. Please contact your Energizer representative for most current information. Contents herein do not constitute a warranty.