



Eveready Battery Company, Inc.  
 Checkerboard Square  
 St. Louis, MO 63164  
 Telephone: 1-800-383-7323  
 Internet: www.energizer.com

## Engineering Data

### ENERGIZER NO. E93

**C**

Alkaline 1.5V

No Added Mercury or Cadmium

Dimensions (mm)

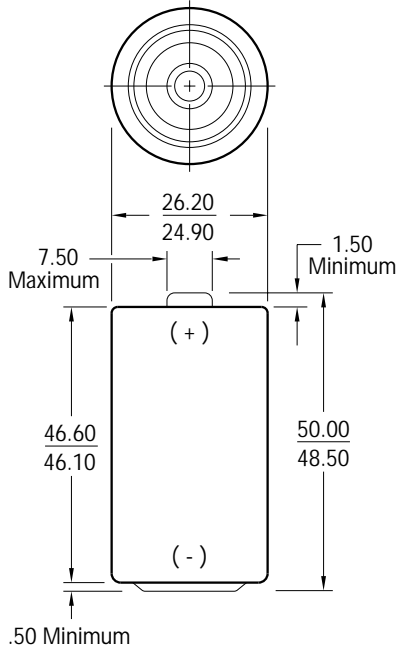

Millimeters	Inches
.50	.020
1.50	.059
7.50	.295
24.90	.980
26.20	1.031
46.10	1.815
46.60	1.835
48.50	1.909
50.00	1.969

**Chemical System:** Alkaline-Manganese Dioxide (Zn/MnO<sub>2</sub>)

**Designation:** ANSI-14A, IEC-LR14

**Battery Voltage:** 1.5 Volts

**Average Weight:** 66.2 grams (2.3 oz.)

**Volume:** 26.9 cubic centimeters (1.6 cubic inch)

**Average Service Capacity ( to 0.8 Volt / cell ): 8.4 Ah**  
 ( Rated capacity at 25 mA continuous drain )

**Cell:** One No. 3-335 (size "C")

**Jacket:** Plastic Label

**TEMPERATURE EFFECTS**  
 Typical Service to 0.8 volts

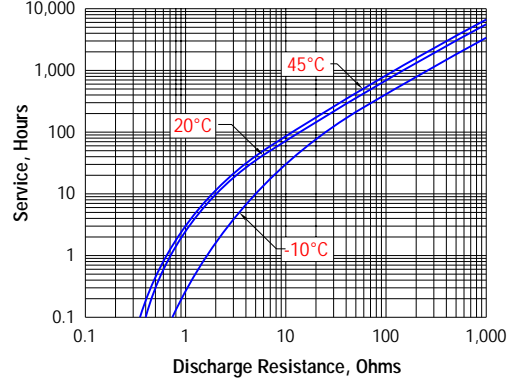

**CONSTANT RESISTANCE PERFORMANCE**  
 Typical Service

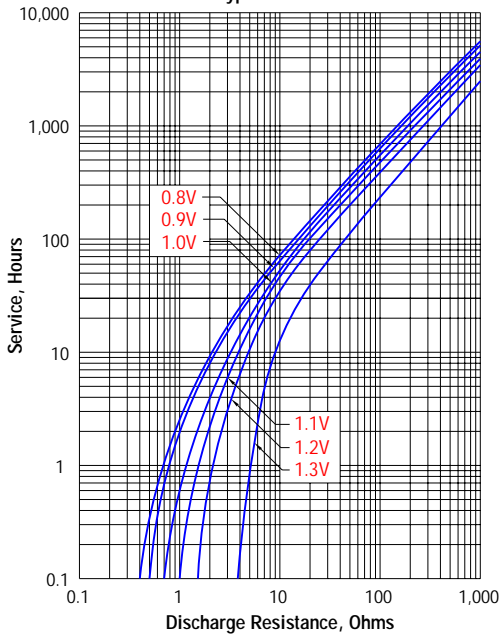

**CONSTANT CURRENT PERFORMANCE**  
 Typical Service

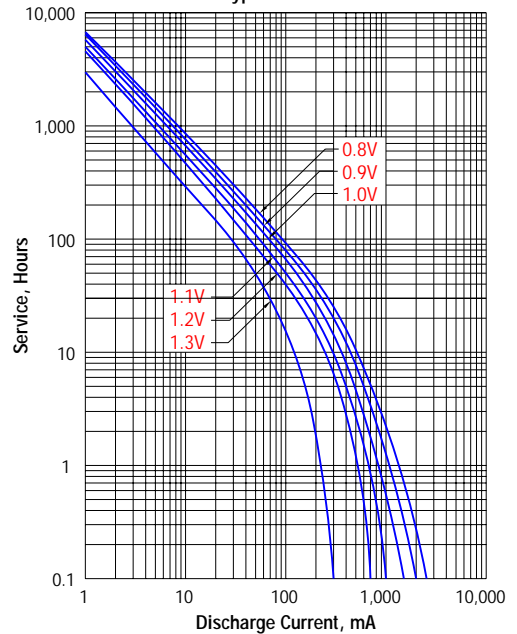

# ENERGIZER NO. E93

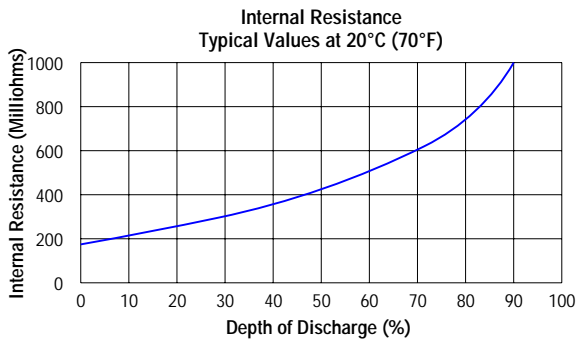

## TYPICAL APPLICATIONS

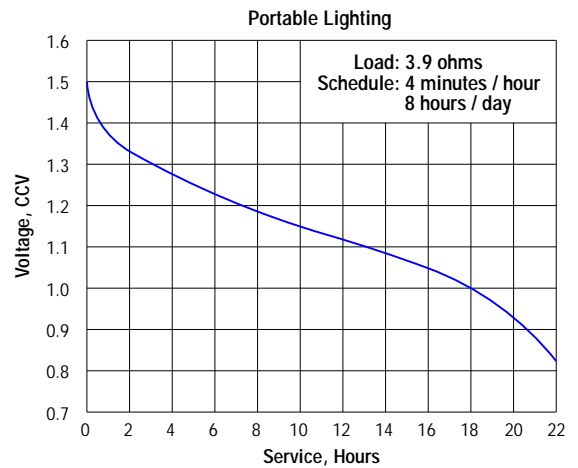
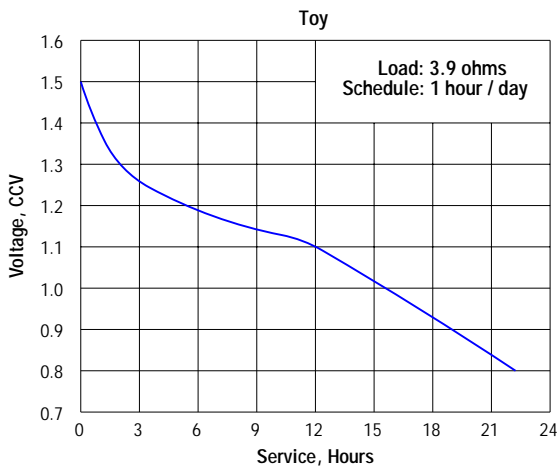
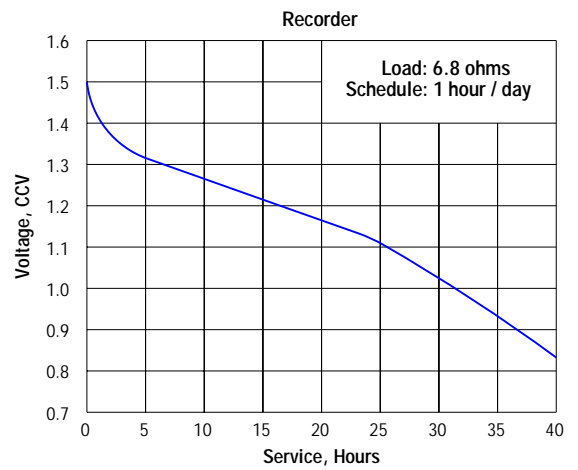
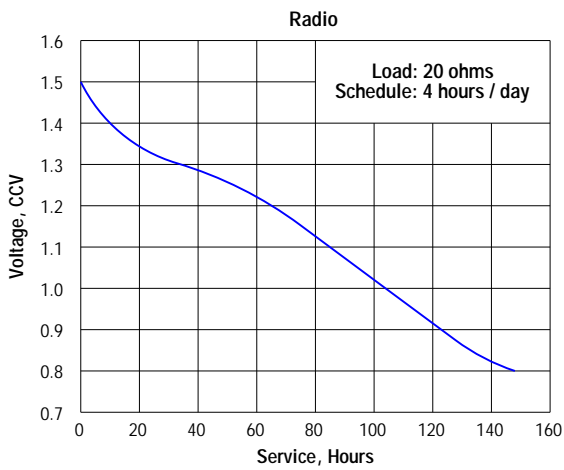

### IMPORTANT NOTICE

This data sheet contains information specific to batteries manufactured at time of its publication. Please contact your Energizer representative for most current information. Contents herein do not constitute a warranty.