

Engineering Data

EVEREADY NO. 529

Alkaline 6V
No Added Mercury or Cadmium

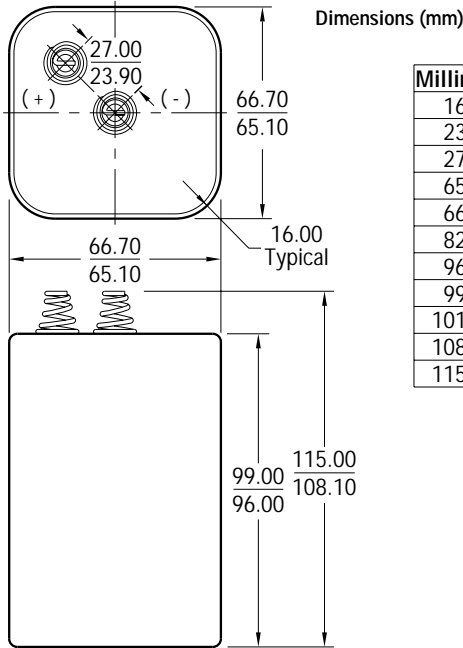

Millimeters	Inches
16.00	.630
23.90	.941
27.00	1.063
65.10	2.563
66.70	2.626
82.60	3.252
96.00	3.780
99.00	3.898
101.60	4.000
108.10	4.256
115.00	4.528

Chemical System: Alkaline-Manganese Dioxide (Zn/MnO₂)

Designation: ANSI / NEDA-908A

Battery Voltage: 6 Volts

Terminal: Coil Spring

Average Weight: 885 grams (31.3 oz.)

Volume: 440.4 cubic centimeters (26.9 cubic inch)

Average Service Capacity (to 0.8 Volt / cell): 26 Ah
 (Rated capacity at 25 mA continuous drain)

Cells: Four No. 3-361 in series.

Jacket: Metal

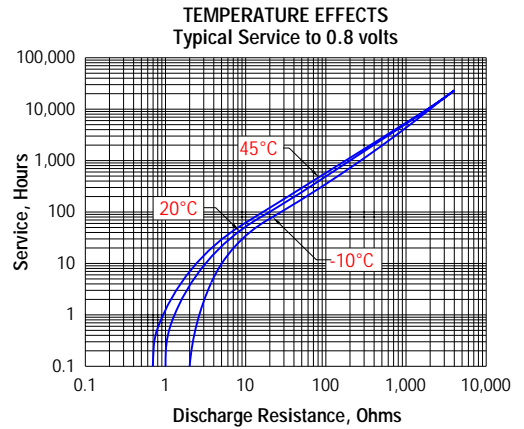

THIS BATTERY SHALL PASS FREELY THROUGH A
 CYLINDRICAL TUBE 82.6 DIAMETER X 101.6 LONG.

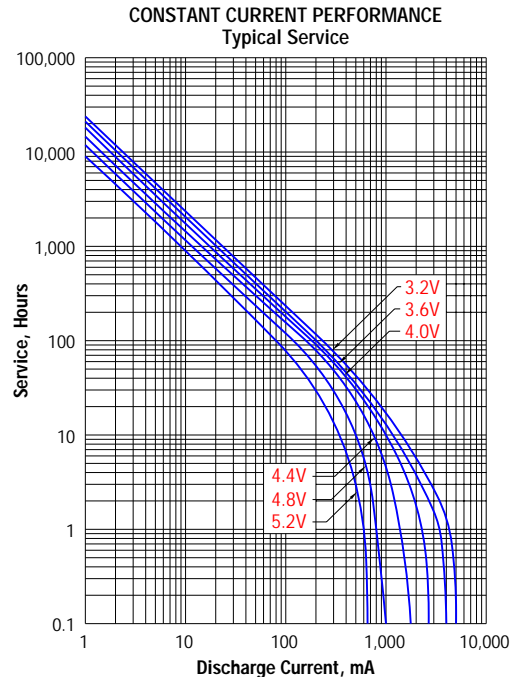
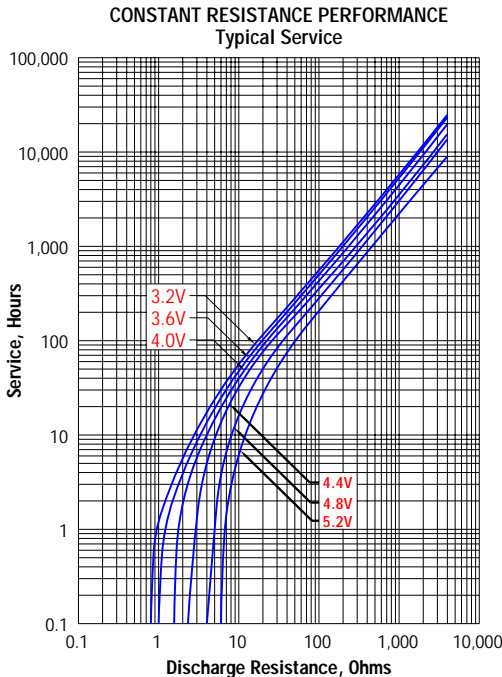

ENERGIZER NO. 529

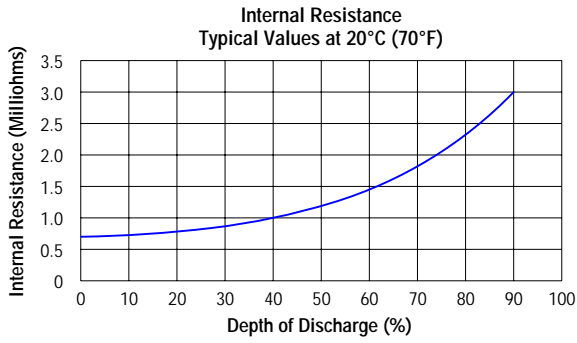

TYPICAL APPLICATIONS

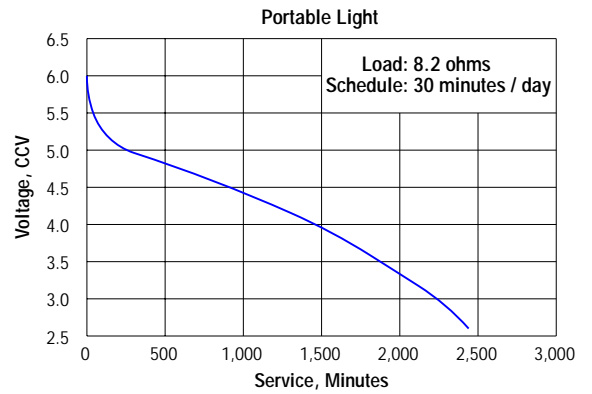
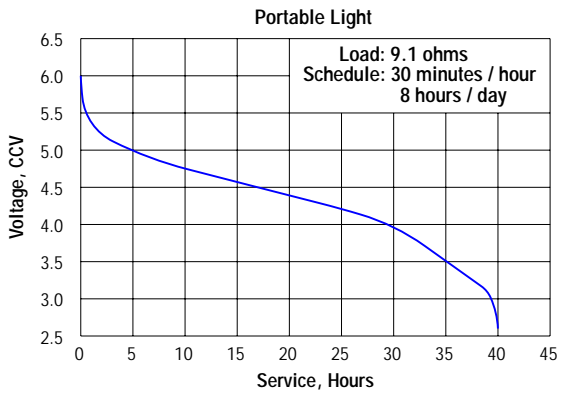
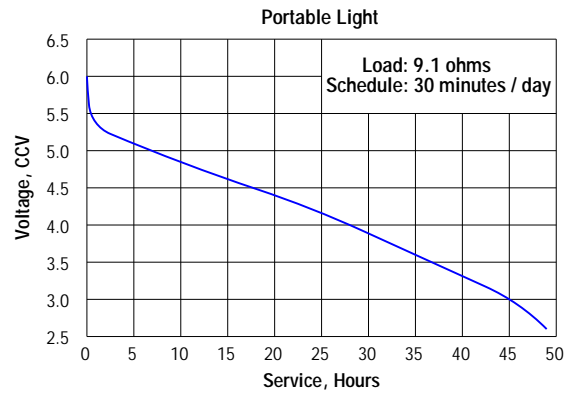
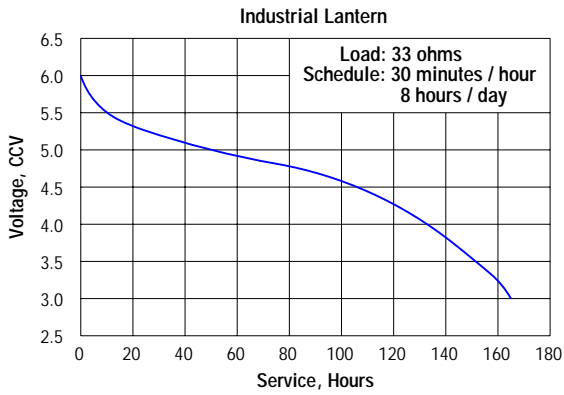
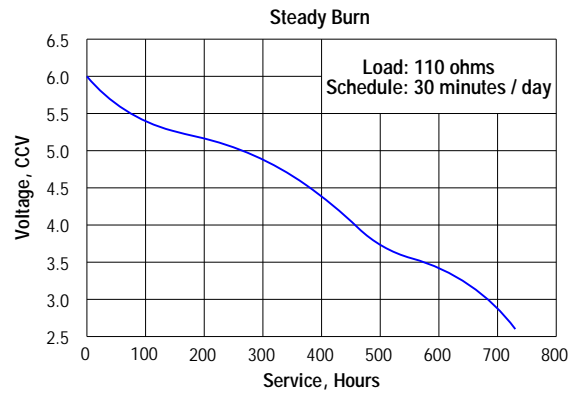
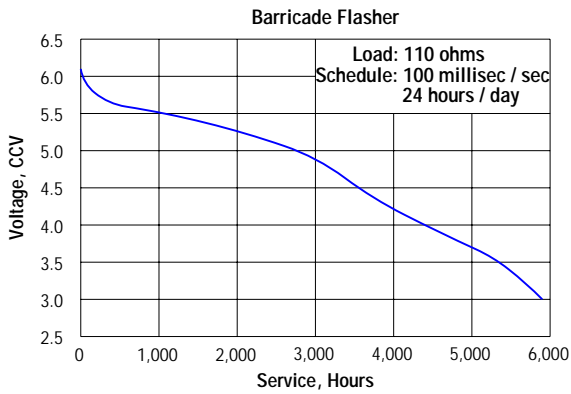

IMPORTANT NOTICE

This data sheet contains information specific to batteries manufactured at time of its publication. Please contact your Energizer representative for most current information. Contents herein do not constitute a warranty.