



Eveready Battery Company, Inc.
 Checkerboard Square
 St. Louis, MO 63164
 Telephone: 1-800-383-7323
 Internet: www.energizer.com

Engineering Data

ENERGIZER NO. 3-350IWC

D

Alkaline 1.5V

No Added Mercury or Cadmium

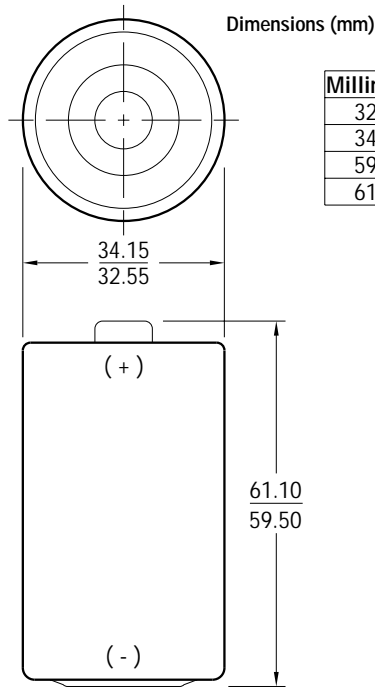

Millimeters	Inches
32.55	1.281
34.15	1.344
59.50	2.343
61.10	2.406

Chemical System: Alkaline-Manganese Dioxide (Zn/MnO₂)

Battery Voltage: 1.5 Volts

Average Weight: 141.9 grams (5.0 oz.)

Volume: 55.9 cubic centimeters (3.4 cubic inch)

Average Service Capacity (to 0.8 Volt / cell): 18 Ah
 (Rated capacity at 25 mA continuous drain)

Jacket: Plastic Label

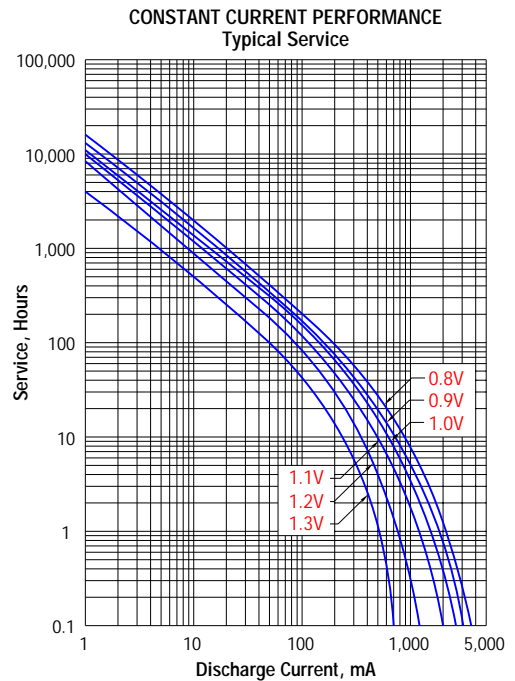
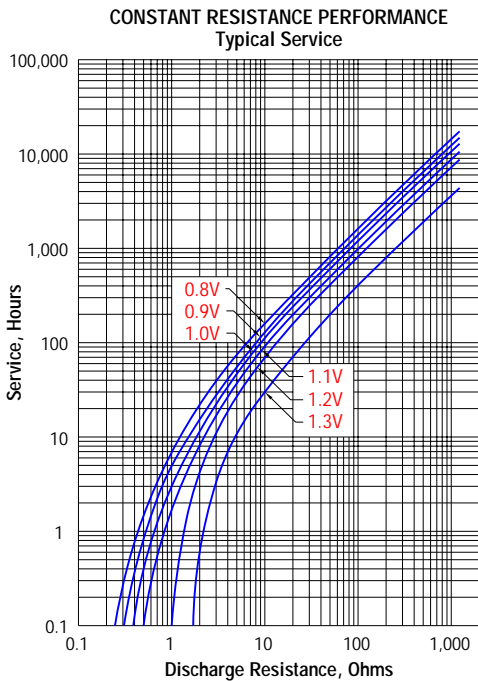
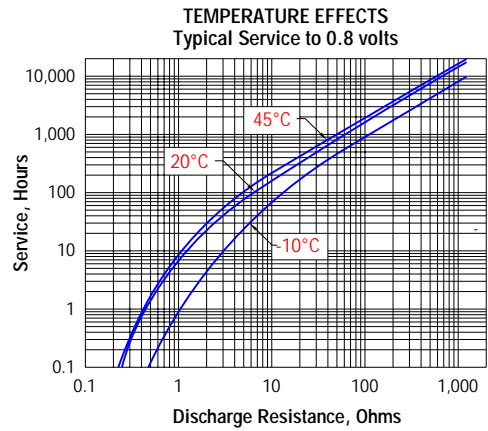

ENERGIZER NO. 3-350IWC

Internal Resistance
Typical Values at 20°C (70°F)

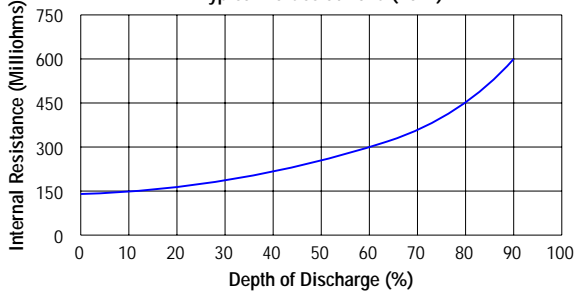

TYPICAL APPLICATIONS

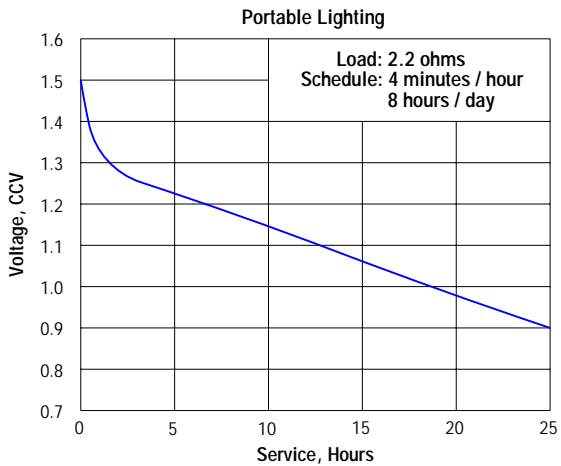
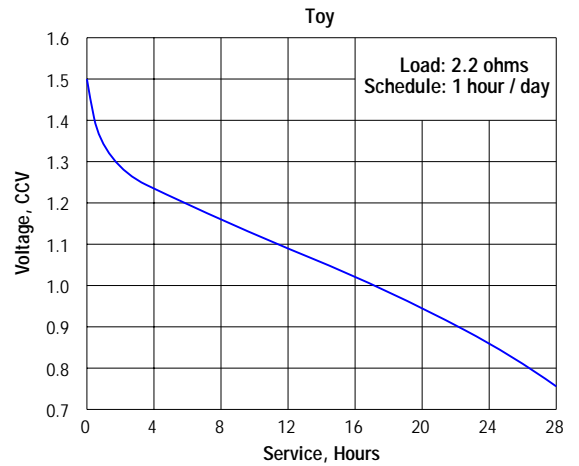
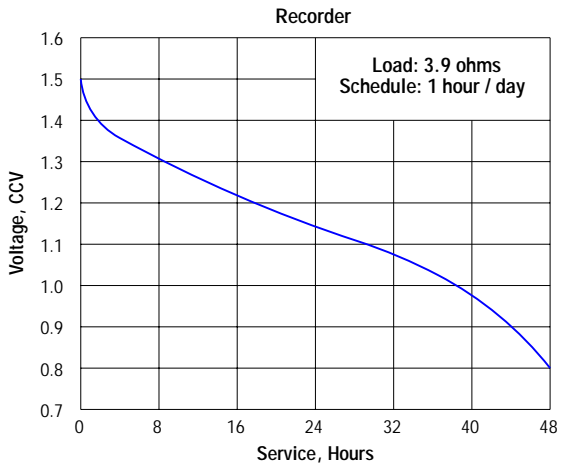
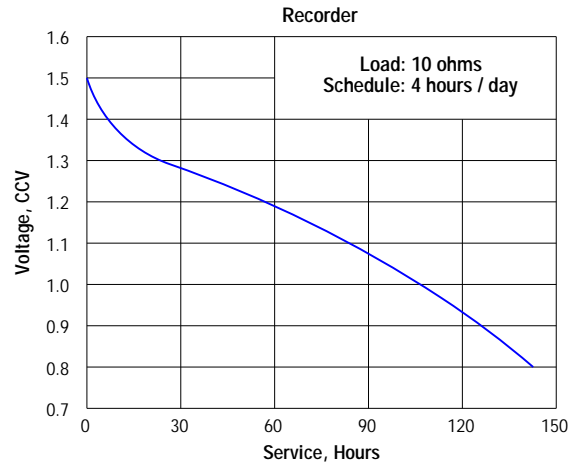
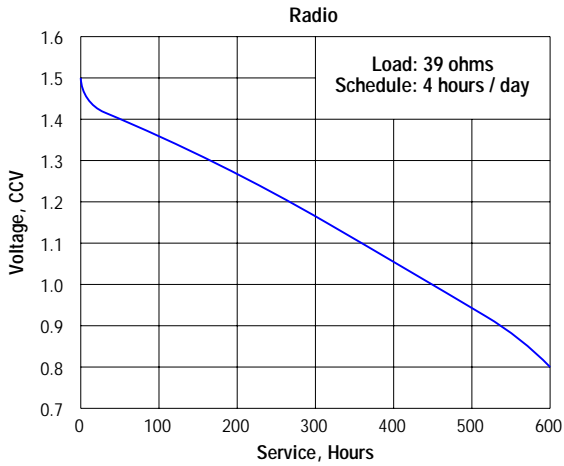

IMPORTANT NOTICE

This data sheet contains information specific to batteries manufactured at time of its publication. Please contact your Energizer representative for most current information. Contents herein do not constitute a warranty.