



Eveready Battery Company, Inc.
 Checkerboard Square
 St. Louis, MO 63164
 Telephone: 1-800-383-7323
 Internet: www.energizer.com

Engineering Data

ENERGIZER NO. 3-315I

AA

Alkaline 1.5V

No Added Mercury or Cadmium

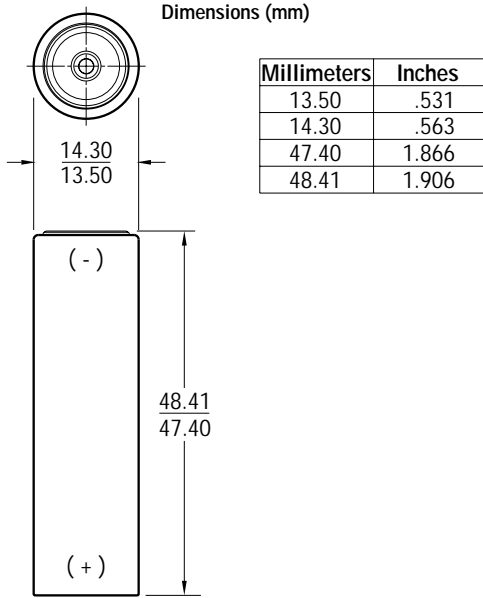

Chemical System: Alkaline-Manganese Dioxide (Zn/MnO₂)

Battery Voltage: 1.5 Volts

Average Weight: 22.4 grams (0.8 oz.)

Volume: 7.8 cubic centimeters (0.5 cubic inch)

Average Service Capacity (to 0.8 Volt / cell): 2.9 Ah
 (Rated capacity at 25 mA continuous drain)

Jacket: Plastic Label

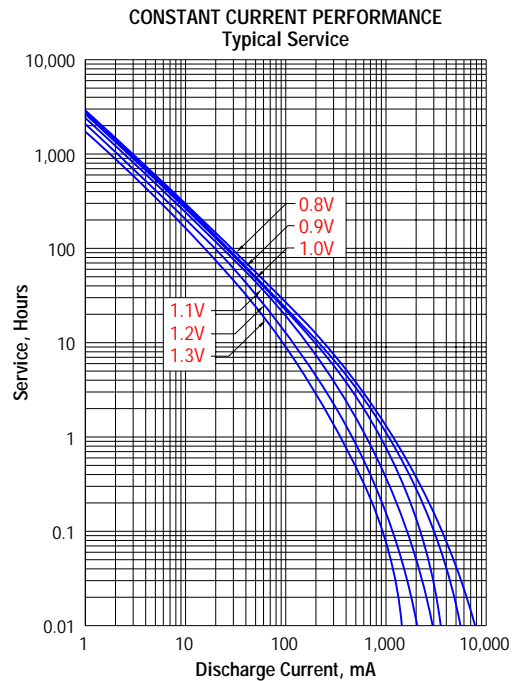
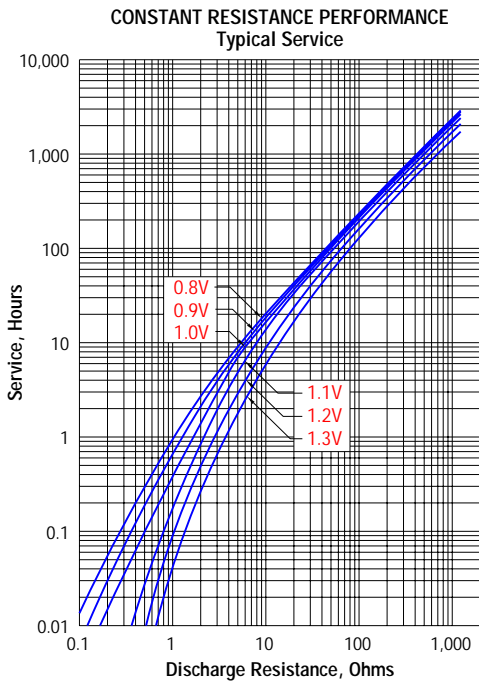
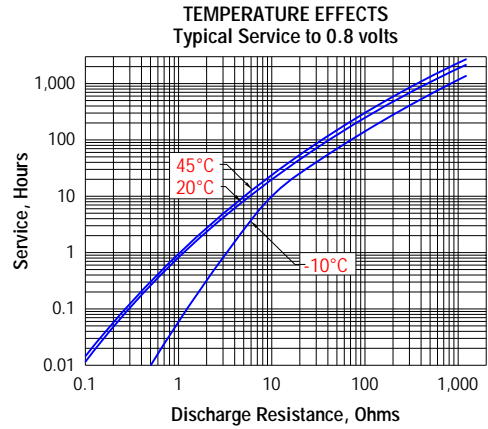

ENERGIZER NO. 3-315I

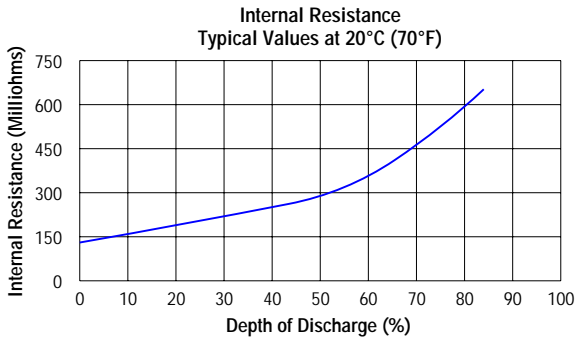

TYPICAL APPLICATIONS

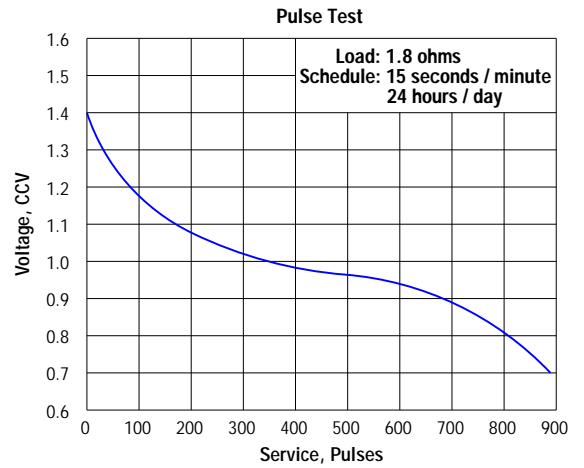
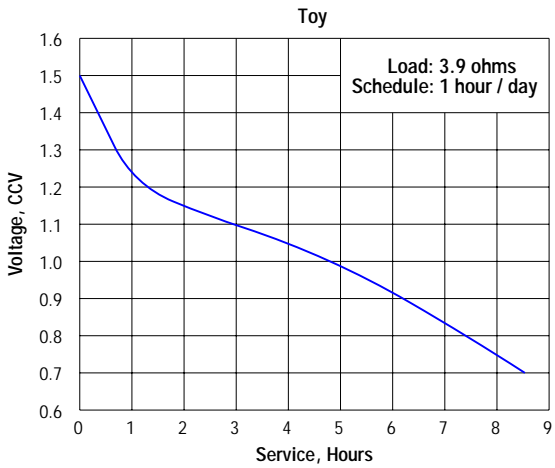
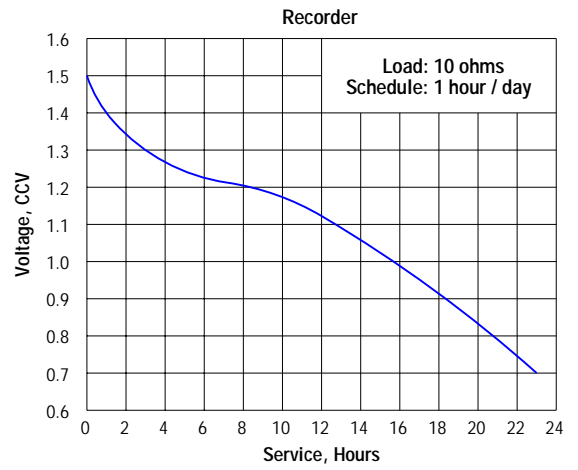
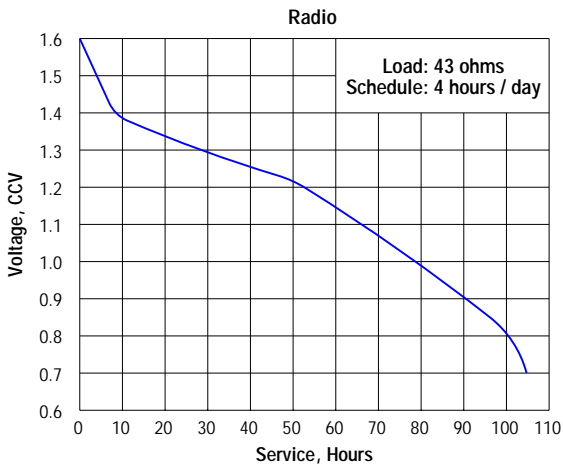

IMPORTANT NOTICE

This data sheet contains information specific to batteries manufactured at time of its publication. Please contact your Energizer representative for most current information. Contents herein do not constitute a warranty.