

Engineering Data

ENERGIZER NO. 3-315

AA

Alkaline 1.5V

No Added Mercury or Cadmium

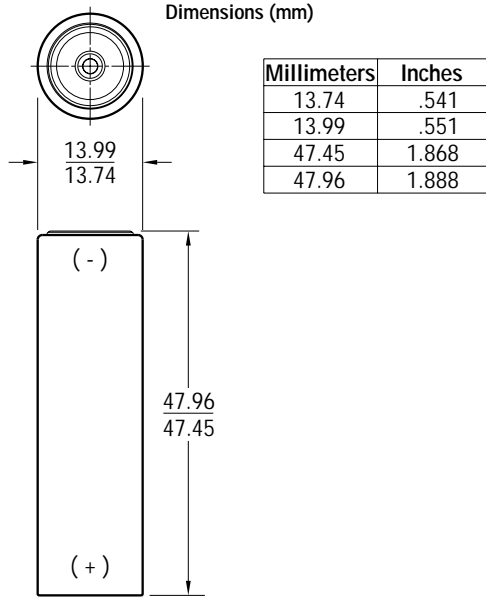

Chemical System: Alkaline-Manganese Dioxide (Zn/MnO₂)

Battery Voltage: 1.5 Volts

Average Weight: 22.4 grams (0.8 oz.)

Volume: 7.4 cubic centimeters (0.5 cubic inch)

Average Service Capacity (to 0.8 Volt / cell): 2.9 Ah
 (Rated capacity at 25 mA continuous drain)

Jacket: None

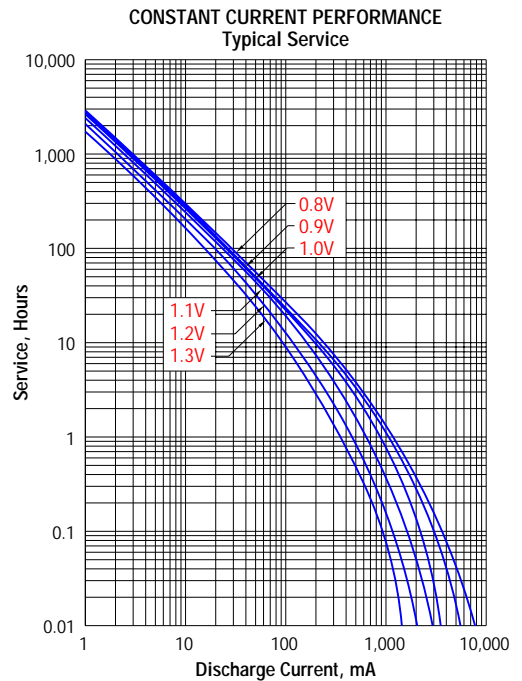
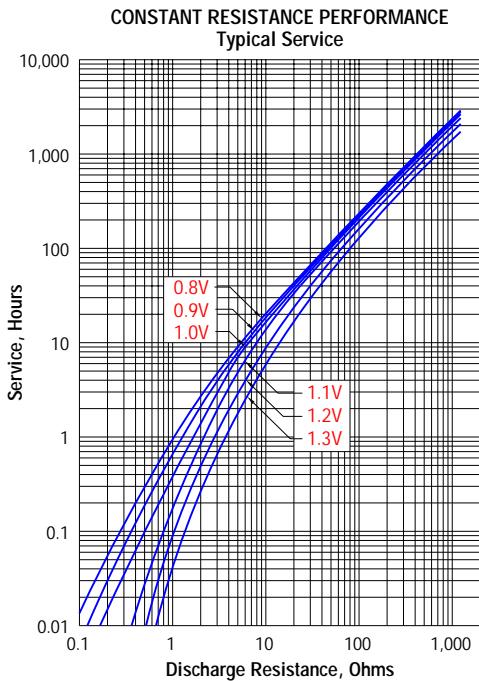
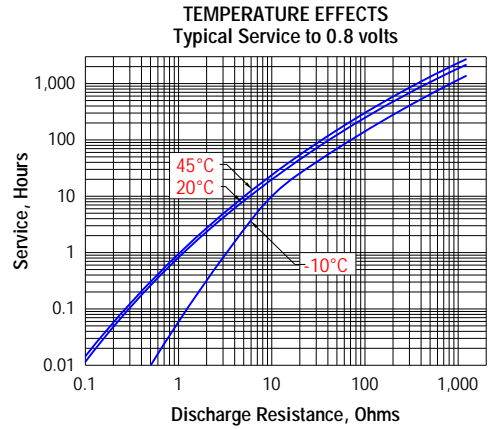

ENERGIZER NO. 3-315

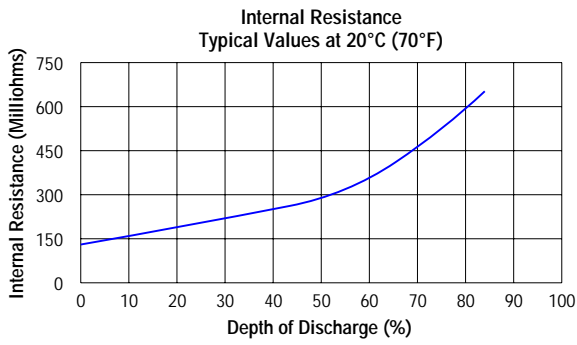

TYPICAL APPLICATIONS

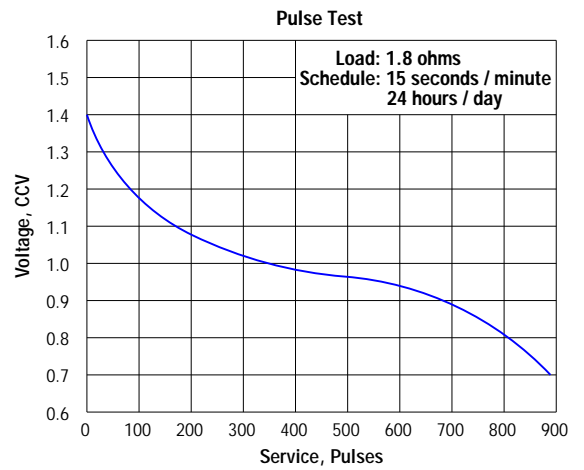
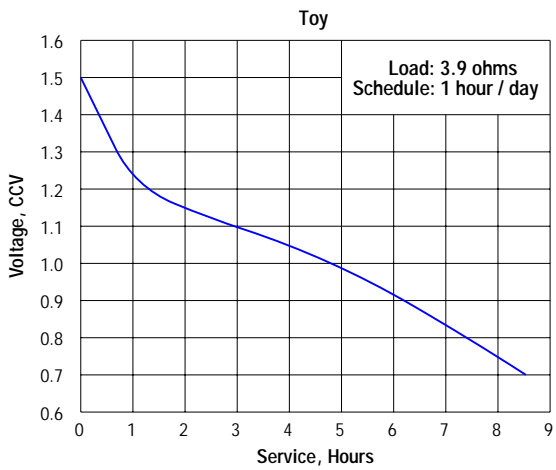
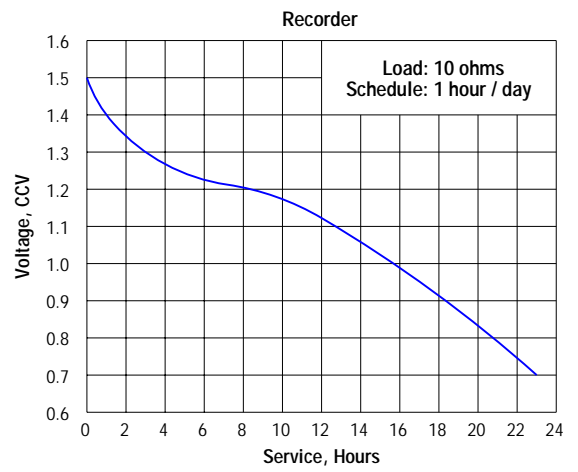
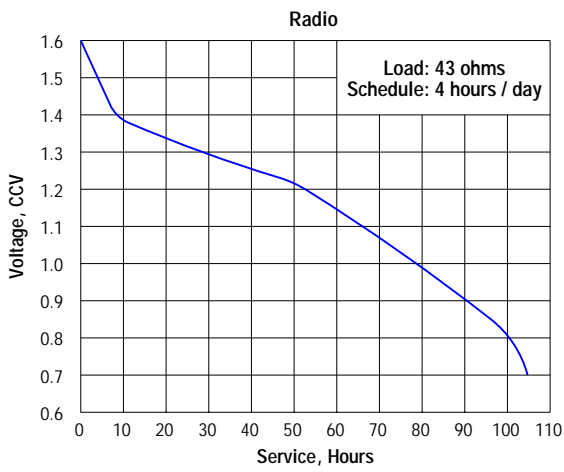

IMPORTANT NOTICE

This data sheet contains information specific to batteries manufactured at time of its publication. Please contact your Energizer representative for most current information. Contents herein do not constitute a warranty.